

Document 1 (F9 Supplement, 10/73) 24 pages:

F 6.1: Description of Heating System

F 6.2: Fault finding

F 6.3: Checking and Adjusting Parts

F 6.4: Removing and Installing Parts

Document 2 (Repair Manual Type 2 -- Supplement 12 of July 77) 18 pages

Repair Manual Type 2

1st edition

SUPPL 12

Apply label

to manual page General

Subject: Heater booster BA6

Technical data

Heat output of BA 6 heater at maximum temperature setting	approx. 5100 to 5900 kcal/h (20,200 to 23,400 BTU/h)
Heat output of engine heating with engine at maximum speed	approx. 12,500 kcal/h (49,600 BTU/h)
Fuel	vehicle fuel
Fuel consumption at maximum temperature	approx. 1.1 to 1.3 liter/h (2.3 to 2.7 US pt/h)
Operating range at an ambient temperature of	10 - 14 volts - 40° to + 20°C (- 40° to + 68°F)
Nominal voltage	12 volts

Power consumption in various operating conditions (in watts)	approx.
Power consumption when vehicle is in motion:	
during start-up with engine running fast	300
during start-up with engine running slowly	400
when heating with engine running fast	160
when heating with engine running slowly	260
Power consumption when engine is not running:	
during start-up	240
when heating	100

CO content in exhaust gas over entire operating range (except start-up)	less than 0.2% of volume
Start-up time (glow time of glow/spark plug)	less than 70 seconds
Run-on time	approx. 80 to 160 seconds



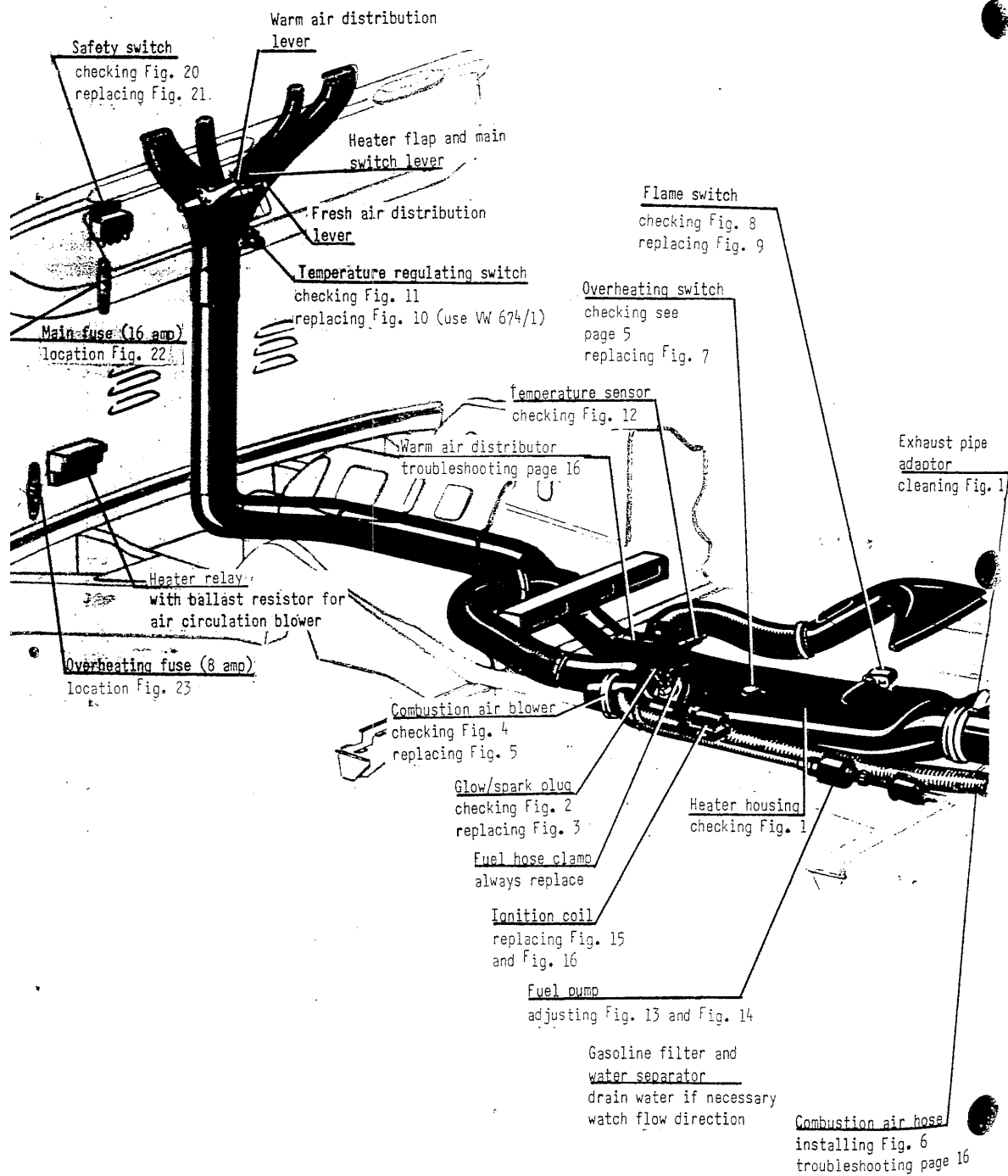

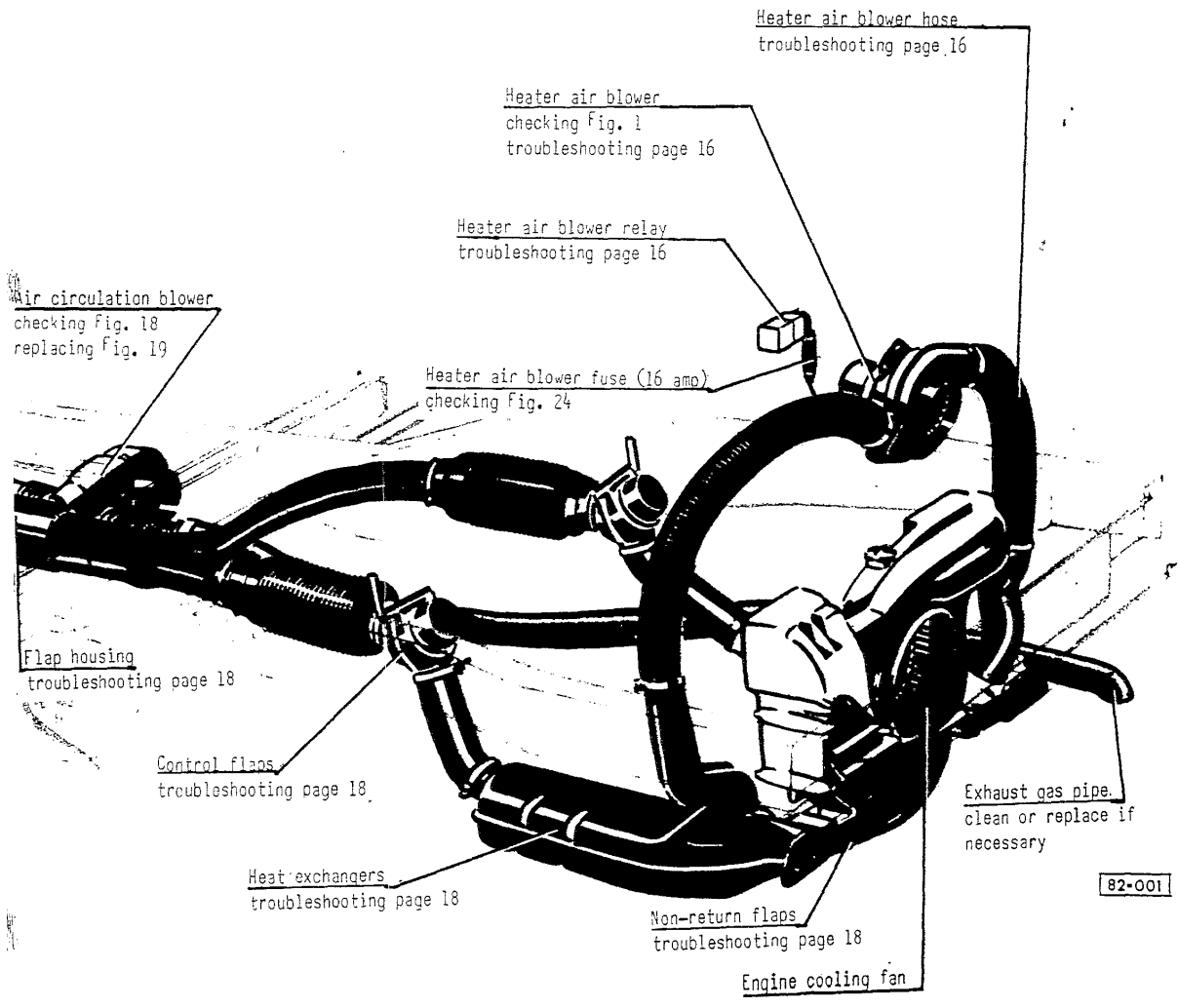

82-001

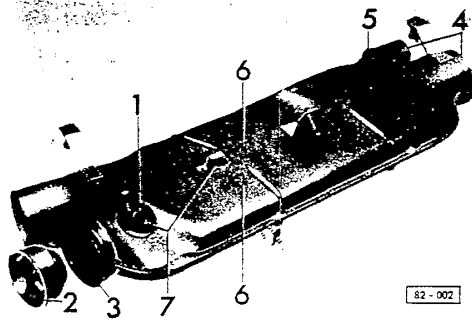

Fig. 1 Heater booster, checking

- 1 - glow/spark plug adaptor - if carbon-fouled clean with toothbrush
- 2 - combustion air blower vane housing - if burned replace
- 3 - combustion chamber - if carbon-fouled clean
- 4 - fresh air inlet - if dirty clean
- 5 - exhaust pipe adaptor - if tar-like deposits are noticeable replace
- 6 - heater booster housing - if distorted by overheating replace
- 7 - gaskets - if damaged by overheating replace

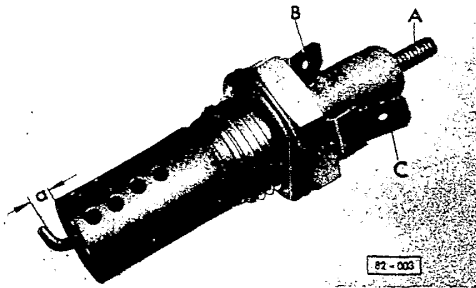

Fig. 2 Glow/spark plug, checking

- A - high tension terminal
- B - glow element terminal
- C - ground terminal

electrode gap "a": 2.5 mm (3/32 in.)
 voltage : 12 volt
 resistance : 4 - 6 k
 current draw of : 10.2 amps
 glow element

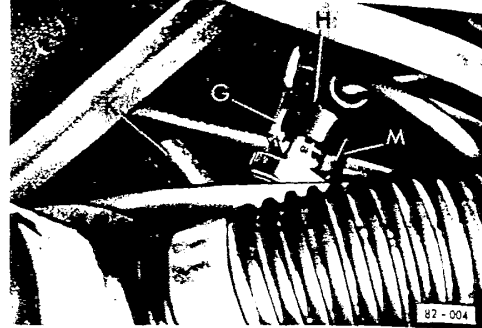

Fig. 3 Glow/spark plug, replacing

- K - fuel connection
- G - glow element terminal
- M - ground terminal
- H - high tension terminal

CAUTION

Connectors of terminals G and M must not contact plug connector H as this may cause ignition trouble

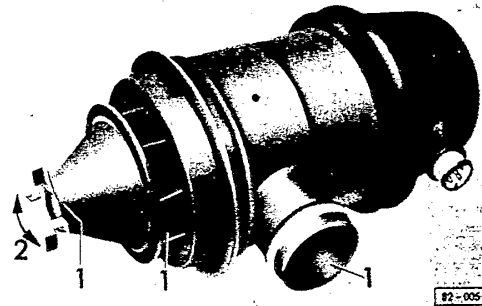

Fig. 4 Combustion air blower, checking

- check for damage caused by overheating (1)
- check for free movement by blower bearing (2) turn in both directions

Note

Fuel is injected by pump every 33 rd revolution of blower shaft. Each injection stroke can be detected by a ticking noise from pump

Number of pump strokes X 33 = speed

speed: 6400 - 7000 rpm
 (at 12 volts after running for 10 minutes)

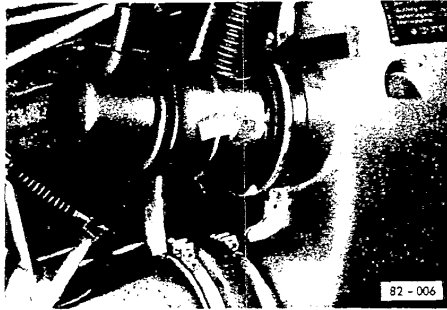
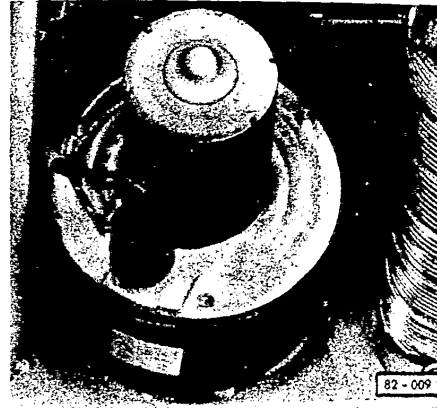

Fig. 5 Combustion air blower, installing

- condensate drain hole in housing must be at bottom (white arrow)

CAUTION

Combustion air hose must fit tightly on blower (black arrow in Fig. 5) and in frame cross member (arrow) Fig. 6



- disconnect air circulation blower
- measure elapsed time when blower is disconnected and until fuel pump stops ticking (overheating fuse blown)
- elapsed time should be 60 to 140 seconds
- if yes - overheating switch is OK (replace fuse)
- if no - replace overheating switch and fuse

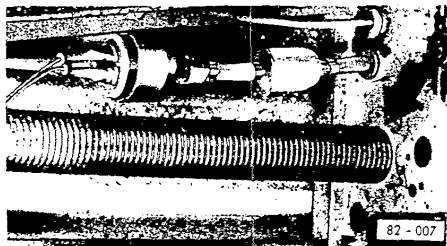
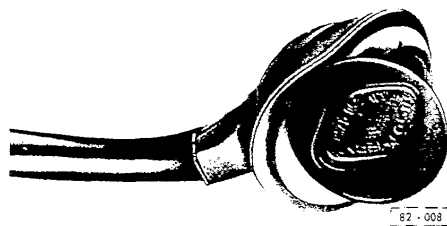

Fig. 6 Combustion air hose, installing

Overheating switch, checking (switch installed)

Work sequence



- turn heater on (engine not running)
- heater must start working within 70 seconds

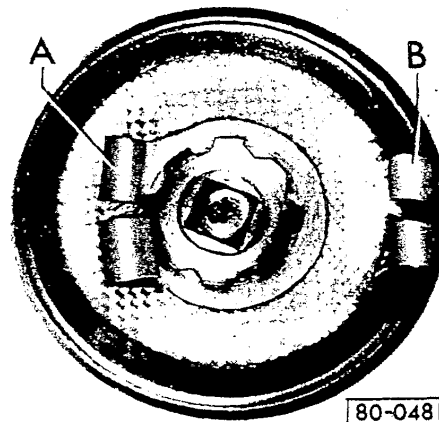

Fig. 7 Overheating switch, replacing

- crimp green wire to terminal A
- crimp brown wire to terminal B
- solder wires (use rosin-core solder)

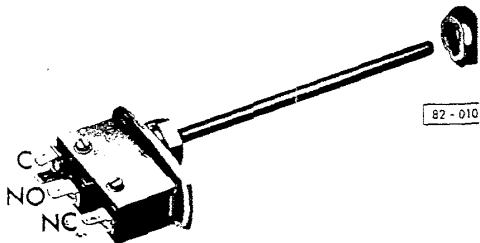

Fig. 8 Flame switch, checking

C = common
 NO = normally open
 NC = normally closed

operation time:
 within 70 seconds at 20°C/68°F

run-on time:
 between 80 and 150 seconds at
 20°C/68°F (see current flow diagram
 on page 82.10 and operating principles)

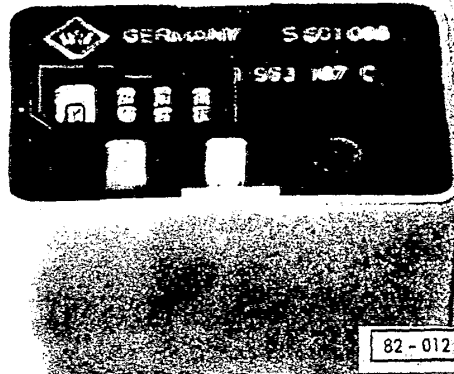

Fig. 10 Temperature regulating switch, replacing

CAUTION

Disconnect battery ground strap before starting to work

- do not interchange wires of terminals 51 and K (outside of multi-pin connector) as this will cause short circuit in switch

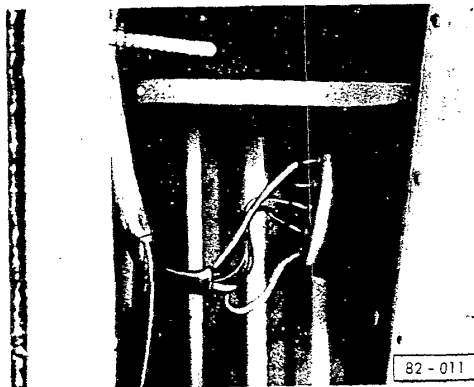

Fig. 9 Flame switch, replacing

- pull rubber grommet off carefully
- remove union nut and pull switch out

CAUTION

Do not bend sensor tube



Fig. 11 Temperature sensor, checking regulating operations (regulating switch installed)

- turn heater on
- disconnect either wire to temperature sensor (very briefly or overheating switch will operate)
- fuel pump should continue to run
- if yes - temperature regulation OK
- if no - replace temperature regulating switch
- bridge temperature sensor terminals
- fuel pump should stop running
- if yes - temperature regulation OK
- if no - replace temperature regulating switch
- if temperature regulation is still not correct, check temperature sensor

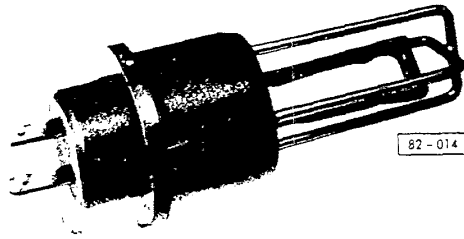

82-014

Fig. 12 Temperature sensor, checking

- place in warm water (60°C/140°F)
- resistance: 3.5 to 5 k

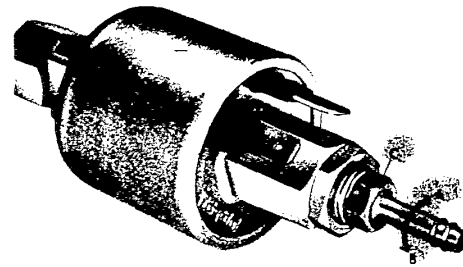

82-014

Fig. 14 Fuel pump, adjusting

to increase amount of delivery:
turn hose adaptor (c) in direction of
arrow B

to decrease amount of delivery:
turn hose adaptor (c) in direction of
arrow A

- lock and seal with paint after
adjustment

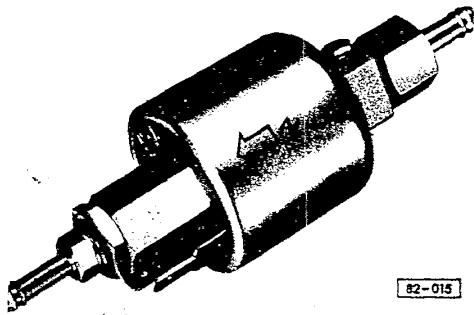

82-015

Fig. 13 Fuel pump, checking
(pump installed)

arrow A = direction of fuel flow

- remove hose on pressure side of pump
- connect a piece of hose to pump and
hold into measuring glass
- turn on heater
- check amount of fuel in measuring
glass after 200 strokes of pump
- amount: 18.4 to 21.7 cm³

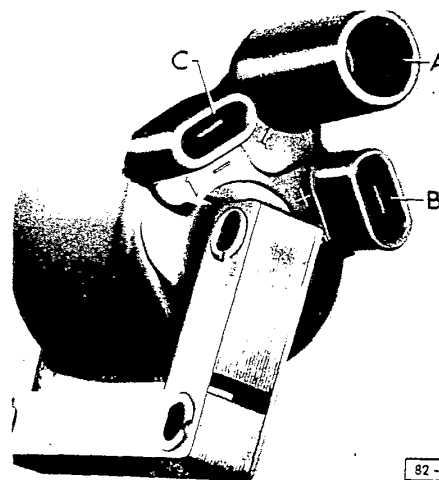

82-017

Fig. 15 Ignition coil, replacing

- A - high tension connection
- B - terminal 15
- C - terminal 1

Supplement 12

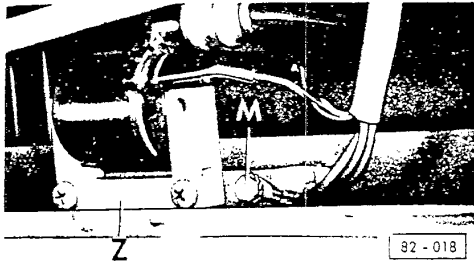

Fig. 16 Ignition coil, replacing

Z - ignition coil
M - ground connection

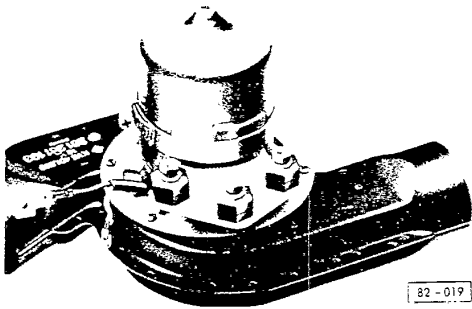

Fig. 17 Heater air blower, checking
(blower installed)

current draw:
6 - 7 amps with engine idling

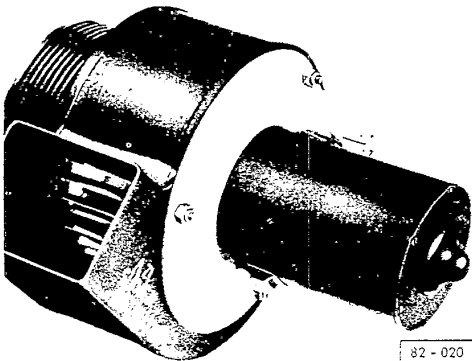

Fig. 18 Air circulation blower, checking
(blower installed)

current draw:
(engine not running)
1st stage: 3.2 to 3.7 amps
(with 1 Ω series resistance)
2nd stage: 6.8 to 7.2 amps

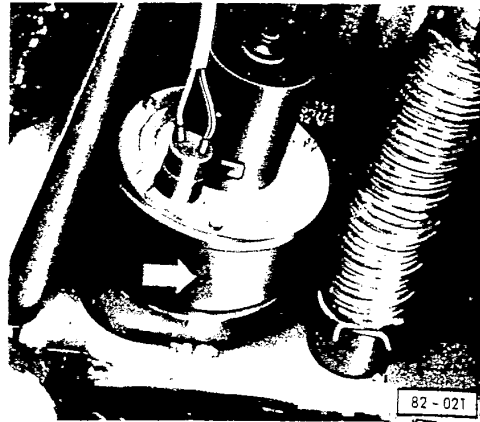

Fig. 19 Air circulation blower, replacing

- condensate drain hole (arrow)
must be at bottom

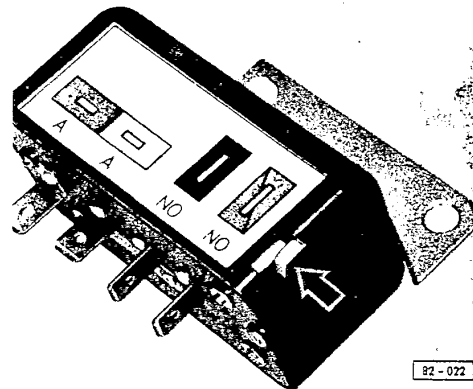

Fig. 20 Safety switch, checking
(switch removed)

- connect ohmmeter to terminals A
- apply 12 volts to terminals NO
- measure elapsed time when voltage is
applied until contact is interrupted
at terminals A

switch response time:
150 to 230 seconds at 20°C/68°F

Note

If safety switch has operated
within required time, press
reset lever in direction of
arrow

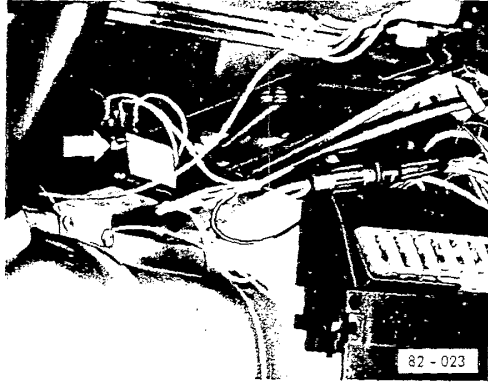

Fig. 21 Safety switch (arrow), replacing
- disconnect battery ground strap

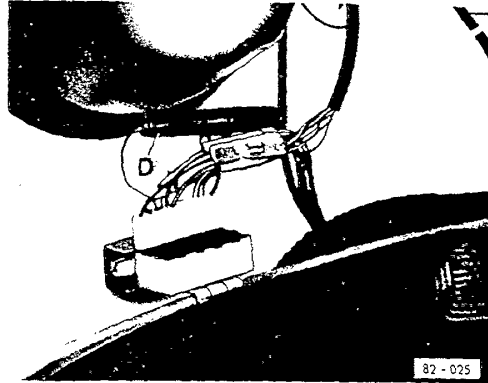

Fig. 23 Overheating fuse, location
D - inline fuse - 8 amps (green wiring).

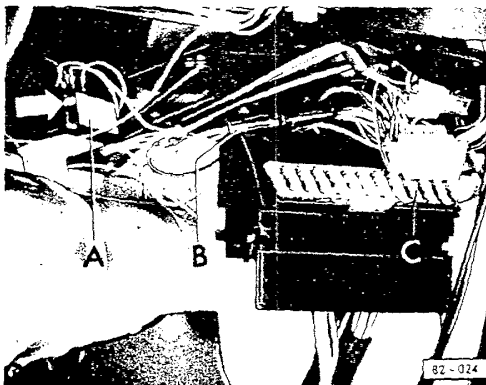

Fig. 22 Safety switch/main fuse/fuse box,
location
A - safety switch (arrow)
B - inline fuse - 16 amps
C - fuse No.10 in fuse box - 16 amps

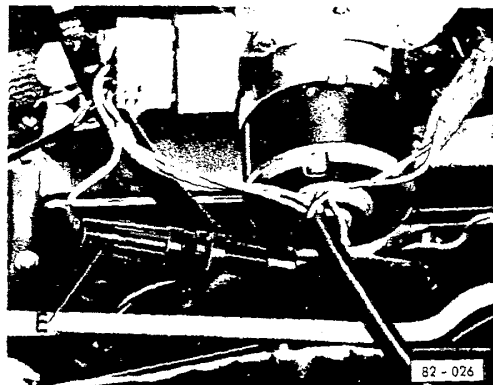
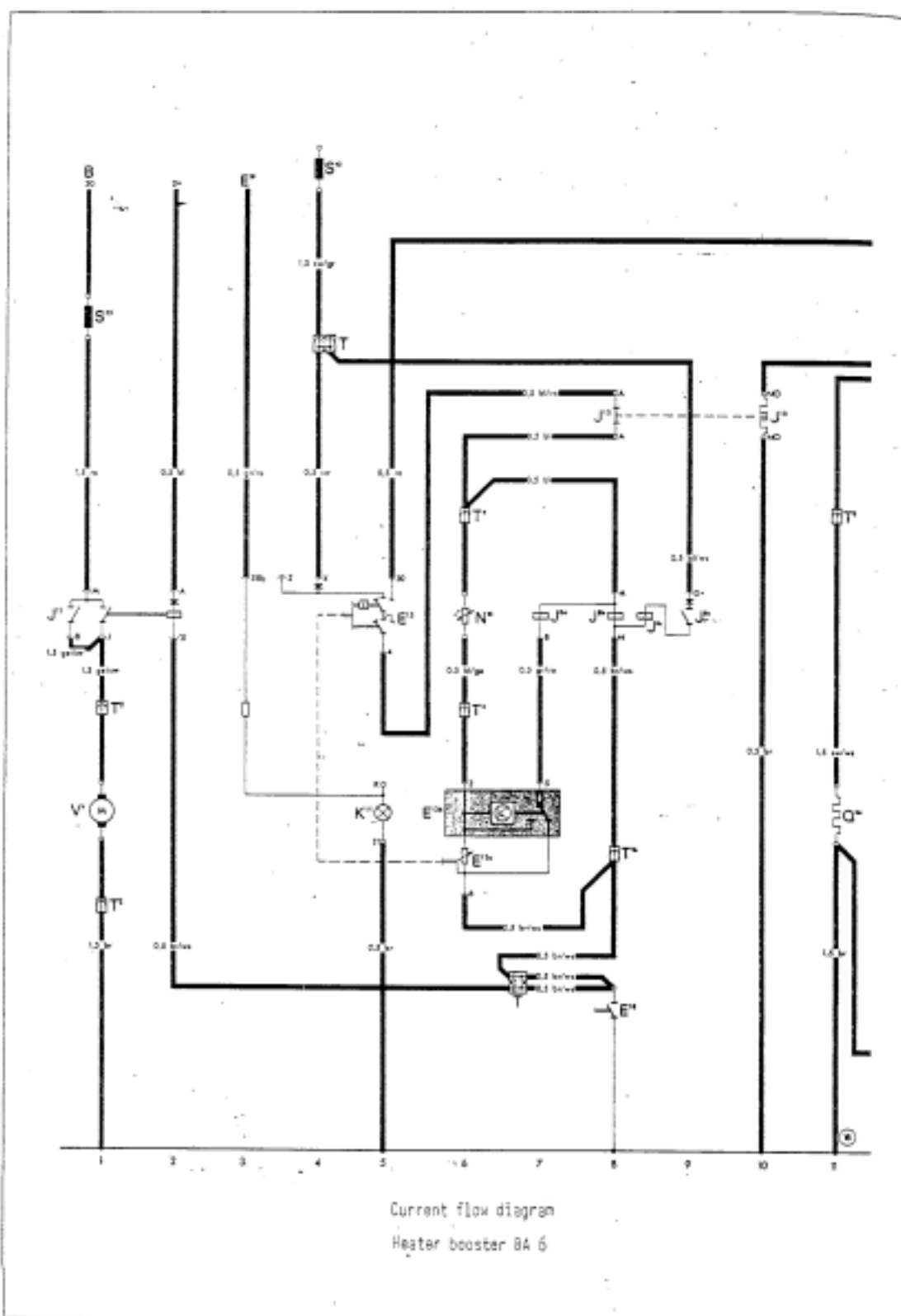
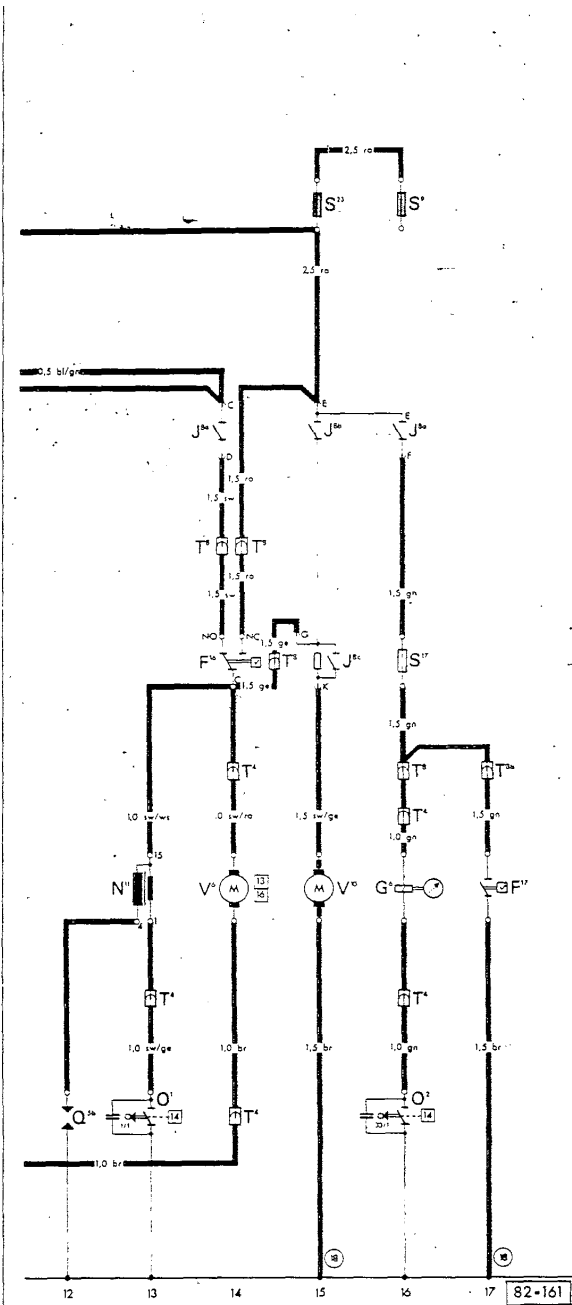

Fig. 24 Heater air blower fuse, location
E - inline fuse - 16 amps

Supplement 12





Description	current track
B - to starter terminal 30	1
D+ - to voltage regulator	2
E1a - Terminal 58b remains vacant	3
E13 - Temperature regulating switch (switch part)	5
E13a - Temperature regulating switch (regulating part)	6
E13b - Temperature regulating switch (electronic circuit)	6,7
E16 - Main switch	8
F16 - Flame switch	14
F17 - Overheating switch	17
G6 - Fuel pump	16
J8a - Relay	7,14,16
J8b - Relay	8,9,15
J8c - Relay	8,15
J10 - Safety switch	8,10
J11 - Relay for heater air blower	1,2
K11 - Warning light	5
N10 - Temperature sensor	6
N11 - Ignition coil	13
O1 - Breaker contact in combustion air blower for ignition coil	13
O2 - Breaker contact in combustion air blower for fuel pump	16
Q5a - Glow spark plug - Glow element	11
Q5b - Glow spark plug - Electrode	12
S9 - Fuse No. 9 in fuse box	16
S10 - Fuse No. 10 in fuse box	4
S17 - Overheating fuse - 8 amps (separate fuse)	16
S23 - Main fuse - 16 amps (separate fuse)	15
S25 - Fuse - 16 amps for heater air blower	1
T - Wire connector (under dashboard)	4,7
T1b - Wire connector, single (under dashboard)	8
T2 - Wire connector, double (on heater air blower)	1
T4 - Connector on combustion air blower	13,14,16
T8 - Connector, 8 point	6,11,14,16
V4 - Heater air blower	1
V6 - Combustion air blower	14
V10 - Air circulation blower	15
13 - Heater ground on coil bracket	11,15,17

Color code
 bl = blue
 br = brown
 ge = yellow
 gn = green
 gr = gray
 ro = red
 sw = black
 ws = white

Supplement 12

Heater operation sequence:

- turn heater on
- heater start-up
- heating
- temperature regulation
- overheating switch
- safety switch
- turn heater off
- heater run-on

Turn heater on

- a - Start vehicle engine and run it at 2000 rpm

check for voltage at:

terminal D+ on regulator

relay for heater air blower (J 11) activates

heater air blower (V 4), starts to deliver air

- b - Press main switch lever (E 16) down fully. Control flaps are opened. Engine heating starts

- c - Turn on temperature regulating switch (E 13) and set heat. Warning light (K 11) lights up and heater starts operating

Heater start up

Heater ignites within 70 seconds if air drawn in is at room temperature.

Start-up process is terminated by flame switch (F 16)

check for voltages at:

terminal 30 and 4 of temperature regulation switch (E 13)

terminals A-A of safety switch (J 10)

relay (J 8) operates contacts E-G and E-K

terminals of fuse (S 23) 16 amp

terminals E-K of relay (J 8b)

air circulation blower (V 10) starts operating

series resistance for air circulation blower (V 10) in relay reduces

output when there is no voltage at terminal D+ on relay. This is the

case when engine is running (voltage at terminal X on temperature

regulating switch). Resistance in relay is bridged by relay contact

(J 8 c) when there is voltage at terminal D+ on relay

terminal C of flame switch (F 16)

combustion air blower (V 6) starts operating

terminal 15 of ignition coil (N 11)

at every revolution of combustion air blower (V 6) ignition

coil (N 11) receives an impulse via breaker contacts (O 1)

check for no or low voltage at:

main switch (E 16)

terminals 6-5 of temperature regulating switch (E 13b) - about 3 volts

terminal B of relay (J 8a) - about 3 volts

relay (J 8a) operates contacts E-F and C-D

check for voltage at:

terminal NO of flame switch (F 16)

glow element of glow/spark plug (Q 5a) is energized. It warms fuel/air mixture to make it readily combustible. It is then ignited by sparks from glow/spark plug (Q 5b)

overheating fuse (S 17) 8 amps

fuel pump (G 6) starts to deliver fuel. At every 33 rd revolution of combustion air blower (V 6) fuel pump (G 6) receives an impulse via breaker contacts (O 2)

Heating

When heater has ignited and warmed up, flame switch (F 16) operates contact C-NC. This ends start-up process

following are de-energized:

terminal NO of flame switch (F 16)

glow element of glow/spark plug (Q 5a) is de-energized

safety switch (J 10) is out of action

Temperature regulation

During regulation there are two voltages at terminal 5 of temperature regulating switch (E 13b). These voltages are controlled by temperature selection via electronic circuitry (E 13b) and temperature sensor (N 10). When heater reaches high heat output, temperature sensor (N 10) records a high temperature and temperature regulating switch (E 13b) indicates a high voltage at terminal 5 as a switching value for relay (J 8a)

check for voltage at:

contact 5 of temperature regulating switch (E 13b)

contact B of relay (J 8a)

relay separates contacts E-F and D-C

following are de-energized:

contact F of relay (J 8a)

contacts of fuse (S 17)

fuel pump stops delivering fuel and combustion stops as heat exchanger cools down. Before flame switch sensor tube can cool off sufficiently to close contacts C-NO (less than 2 minutes) temperature sensor (N 10) registers lowered temperature and switches on heater

check for no or low voltage at:

contact 5 of temperature regulating switch (E 13b) - about 3 volts

contact B of relay (J 8a) - about 3 volts

relay (J 8a) connects contacts E-F and D-C

check for voltage at:

terminal F of relay (J 8a)

fuel pump (G 6) starts delivering fuel

Overheating switch

If heater should overheat, overheating switch (F 17) closes and causes a short circuit which blows 8 amp fuse (S 17).

Overheating switch (F 17) operates if insufficient air is flowing past heat exchanger or temperature regulating switch (E 13b) does not regulate

this de-energizes:

terminal of fuel pump (G 8)
flame goes out and run-on starts

Safety switch

Safety switch (J 10) operates when flame switch (F 16) holds contacts C-NO longer than approximately two to four minutes (because combustion has not taken place in heater), re-ignition has not taken place after regulation, or because flame switch (F 16) is defective.

check for voltage at:

terminals C-NO of flame switch (F 16)
terminals D-C of relay (J 8a)
glow element of safety switch (J 10) heats up for about two to four minutes and contact connection A-A is interrupted

following are de-energized:

terminal A of relay (J 8)
all connections in relay (J 8) are interrupted
terminal G of relay (J 8)
terminal K of relay (J 8)
combustion air blower (V 6) stops
ignition coil (N 11) is de-energized
air circulation blower (V 10) stops
terminal F to relay (J 8)
fuel pump (G 6) stops working

Turning heater off

Turn knob of temperature regulating switch (E 13) back to stop position. Press main switch (E 16) up to open ground contact

following is de-energized:

terminal (4) on temperature regulating switch (E 13b)
terminal A on relay (J 8)
all connections in relay (J 8) are interrupted

Heater run-on

Run-on lasts for about 80-160 seconds at an ambient temperature of 20 C (68 F) and is shorter at lower temperatures. Run-on is necessary in order to clear all traces of gas from the heat exchanger and cool it down. Flame switch limits run-on period

following is de-energized:

- terminal F of relay (J 8a)
- fuel pump (G 6) stops working

check for voltage at:

- terminals of fuse (S 23) 16 amps
- terminals NC-C of flame switch (F 16)
 - combustion air blower (V 6) delivers air
- terminal G of relay (J 8)
- terminal K of relay (J 8)
 - air circulation blower (V 10) delivers air.
 - When heat exchanger has cooled down, flame switch (F 16) operates contacts C-N0

following are de-energized:

- terminal C of flame switch (F 16)
- terminal K of relay (J 8c)
 - air circulation blower (V 10) and combustion air blower (V 6)
 - are de-energized and run-on is finished

Supplement 12

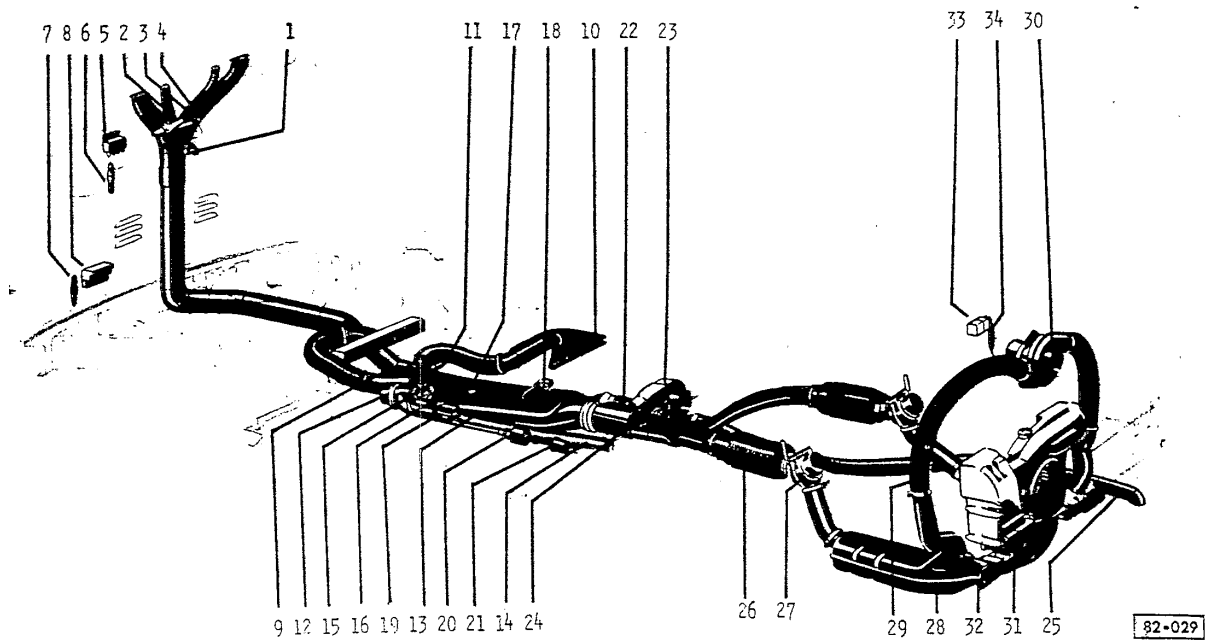

Trouble	Operating conditions
10th fuse in fuse box blown	Engine running; main switch on (lever 3) Temperature regulating switch (1) on
Separate 16 Amp. fuse for heater air blower (34) blown	Main switch on (lever 3); engine running
Main fuse (6) blown	Main switch on (lever 3) Temperature regulating switch (1) on
Safety switch (5) activated	Main switch on (lever 3) Temperature regulating switch (1) on
Overheating switch (17) and 8 Amp. fuse have operated	Main switch on (lever 3) Temperature regulating switch (1) on
Heater does not run-on	Heater and engine turned off
Air circulation blower does not run at two speeds	Main switch on (lever 3); temperature regulating switch (1) on; ignition turned on and off
Heat output inadequate and/or heater uses too much fuel	Engine running; heater turned on
Air circulation (23) and combustion air blower (12) continue to run after run-on period although heater is turned off	Engine running; main switch on (lever 3) Temperature regulating switch (1) just turned off
Heater air blower (3) continues to run	Heater and engine just turned off
Heater smokes	Main switch on (lever 3) Temperature regulating switch (1) on

Symbols denote degree of trouble probability

- = Highly probable
- △ = Not so probable
- = Seldom

Trouble caused by										see page	
										1 - Temperature regulating switch	2,6
										3 - Lever for flaps and ground (main switch)	2
										5 - Safety switch	2,8
										6 - Main fuse (16 amp)	2,9
										7 - Overheating fuse (8 amp)	3,9,18
										8 - Heater relay	2
										9 - Warm air distributor blocked	2
										10 - Warm air vent blocked	2
										11 - Temperature sensor	2,7
										12 - Combustion air blower	2,4
										13 - Heater housing	2,4
										14 - Combustion air hose	2,5
										15 - Glow/spark plug	2,5
										16 - fuel connection	2,4
										17 - Overheating switch	2,5
										18 - Flame switch	2,6
										19 - Coil	2,7,8
										20 - Fuel pump	2,7
										21 - filter	2
										22 - Exhaust pipe adapter	2,4
										23 - Air circulation blower	3,8
										24 - Flap housing	3,18
										25 - Exhaust pipe	3
										26 - Warm air hose	3
										27 - Control flap	3,18
										28 - Heat exchanger	3,18
										29 - Heater air hose	3
										30 - Heater air blower	3,18
										32 - Non-return flaps	3,18
										33 - Relay for heater air blower	3
										34 - Fuse for heater air blower	3,9

Supplement 12

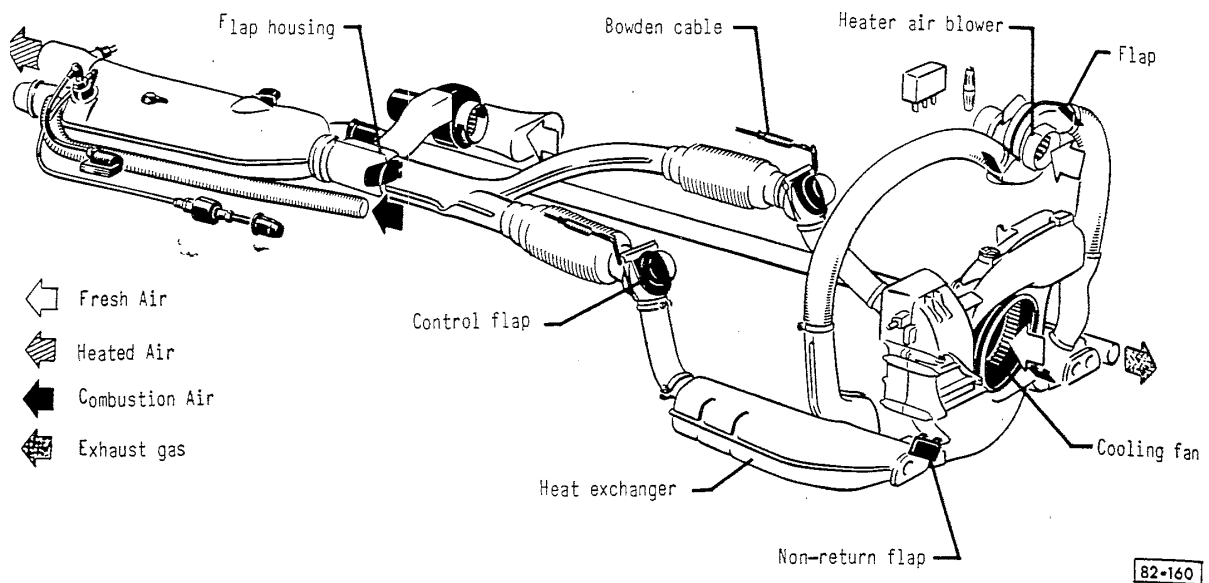

Complaint	Check for	Possible cause	Correction
Excessive fuel consumption (heater makes up for lack of heat from engine)	Air from heater air blower escaping through cooling fan duct (engine idling)	Engine fan flaps do not close	Replace cooling fan non-return flaps
	Air from cooling fan escaping through heater air blower	Heater air blower flaps broken	Replace housing and flaps for heater air blower
	Warm air escaping through control flaps	Control flap cables not adjusted	Adjust control flap cables
	Warm air escaping	Heat exchangers rusted	Replace heat exchangers
Overheating fuse (8 amp) blows	Lack of warm air (when vehicle engine is not running)	Flap in housing stops air flow from air circulation blower	Replace flap housing

**BA 6 Heater for Type 2
(from August 1973)**

Description

The BA 6 heater is installed in the space between the floor plates and the underfloor plates. It is connected to the heater ducts of the normal engine heating system.

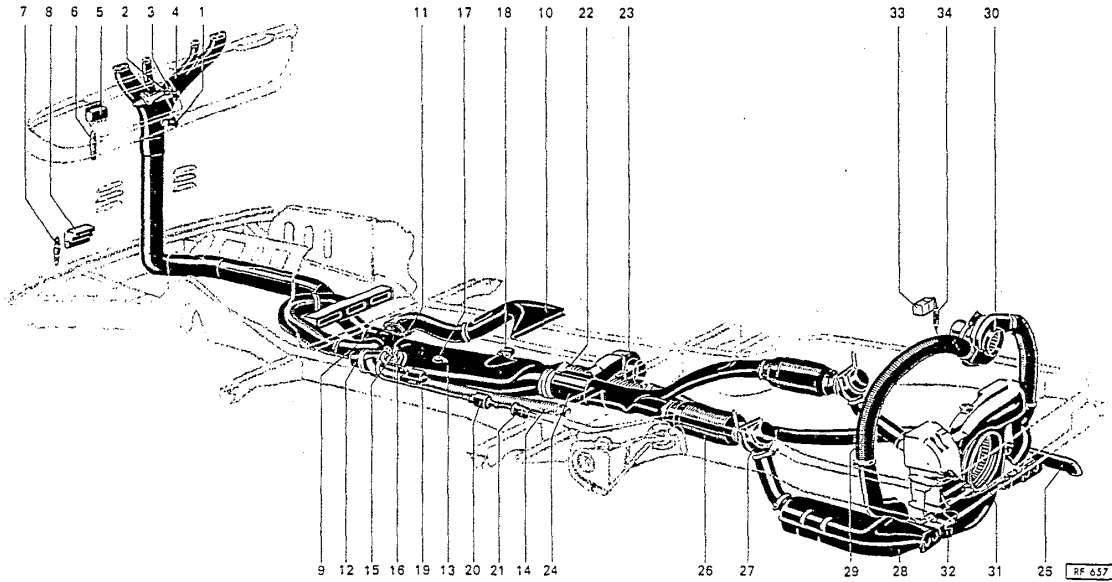

- | | |
|---|---|
| <ul style="list-style-type: none"> 1 - Temperature regulating switch 2 - Warm air distribution lever 3 - Lever for heater flaps and main switch 4 - Fresh air distribution lever 5 - Safety switch 6 - Main fuse (16 Amp.) 7 - Overheating switch (8 Amp.) 8 - Relay 9 - Warm air distributor 10 - Heater outlet 11 - Temperature sensor 12 - Combustion air blower 13 - Heater 14 - Combustion air hose 15 - Glow-spark plug 16 - Fuel connection 17 - Overheating switch 18 - Thermostwitch | <ul style="list-style-type: none"> 19 - Coil 20 - Metering pump 21 - Filter 22 - Injector 23 - Air circulation blower 24 - Flap housing 25 - Exhaust pipe 26 - Warm air hose 27 - Warm air flap 28 - Heat exchanger 29 - Warm air hose*) 30 - Warm air blower*) 31 - Cooling air fan*) 32 - Non-return flap*) 33 - Warm air blower relay 34 - Separate fuse for warm air blower |
|---|---|

*) not installed in Type 2/1600